

DSF & DSH Design Wall Panels



ATAS INTERNATIONAL, INC
 Allentown PA
 610-395-8445
 Mesa AZ
 480-558-7210

Design Wall Panel Profile Detail

REV. NO.	DATE	DESCRIPTION OF REVISION	BY	APP	TITLE	DWG. NO.	DR	KRK	DATE	7/26/2016
							APP	DAS	DATE	7/26/2016
							MATERIAL			
							SH. SIZE	B	SCALE	X:X

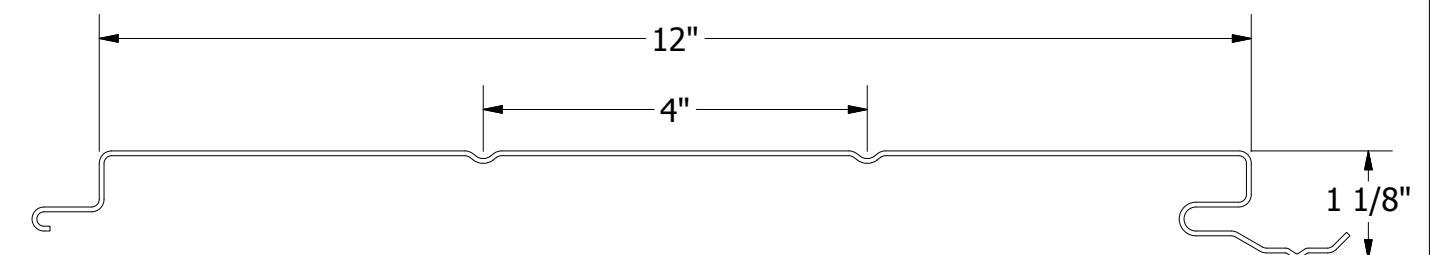
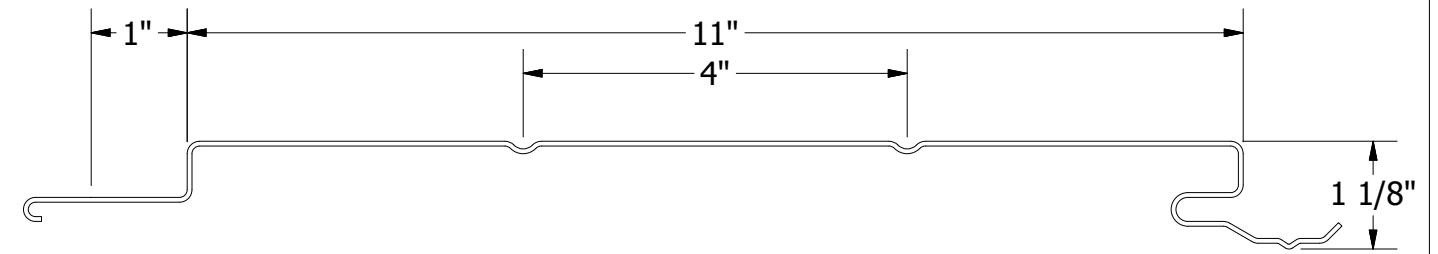
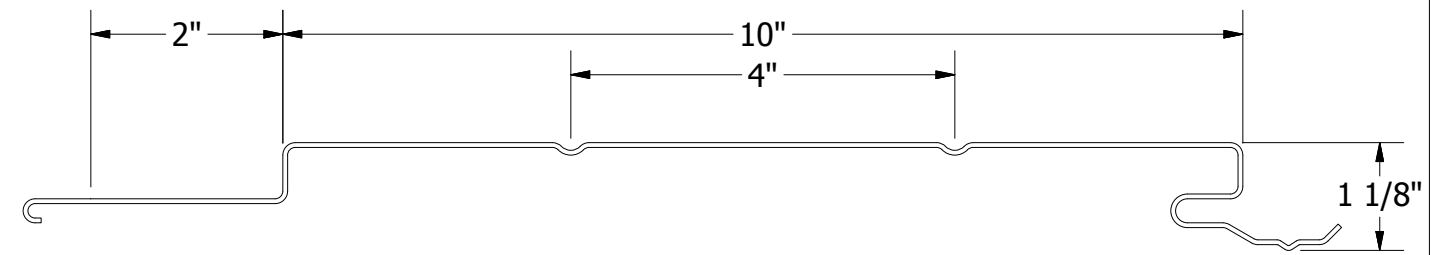
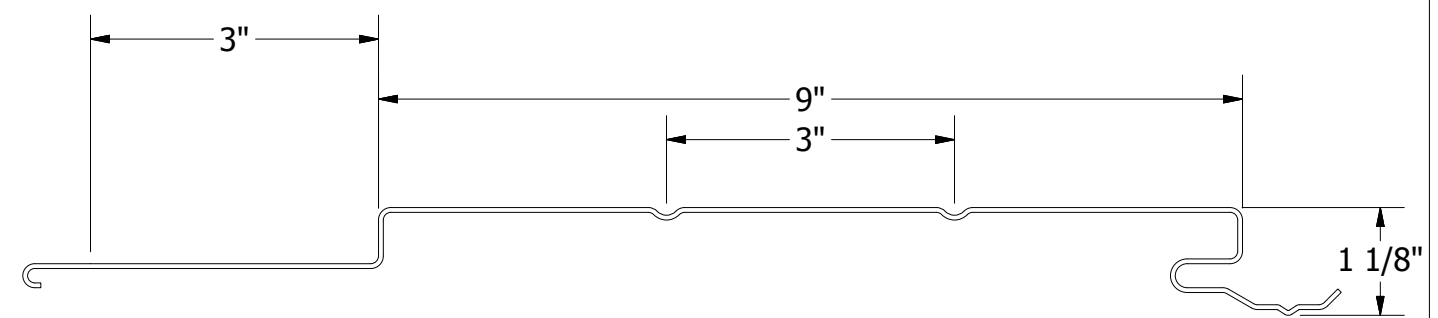
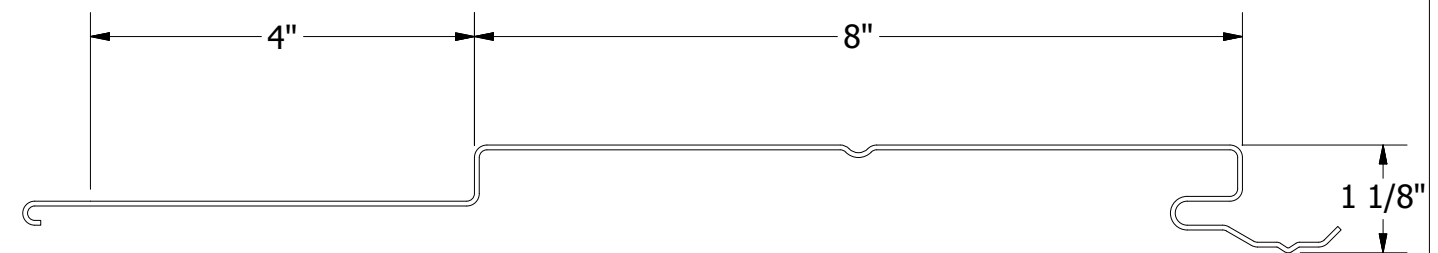
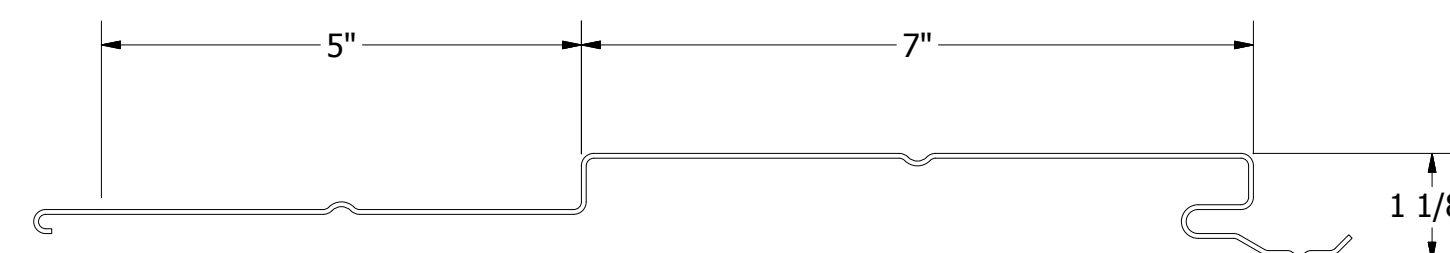
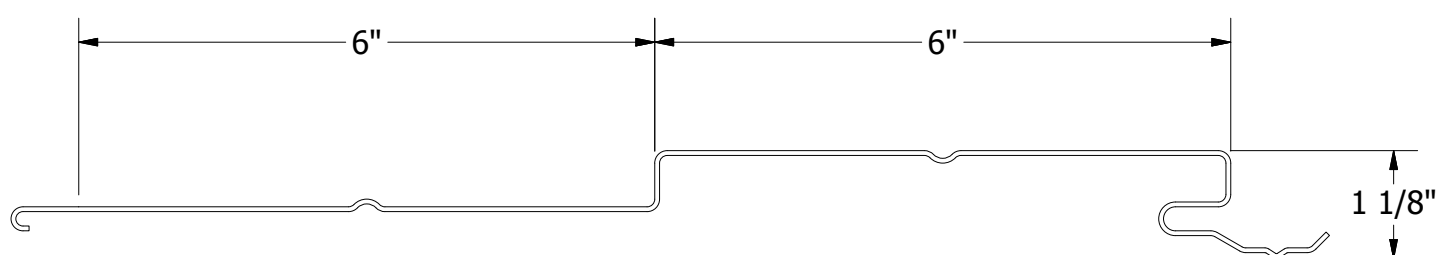
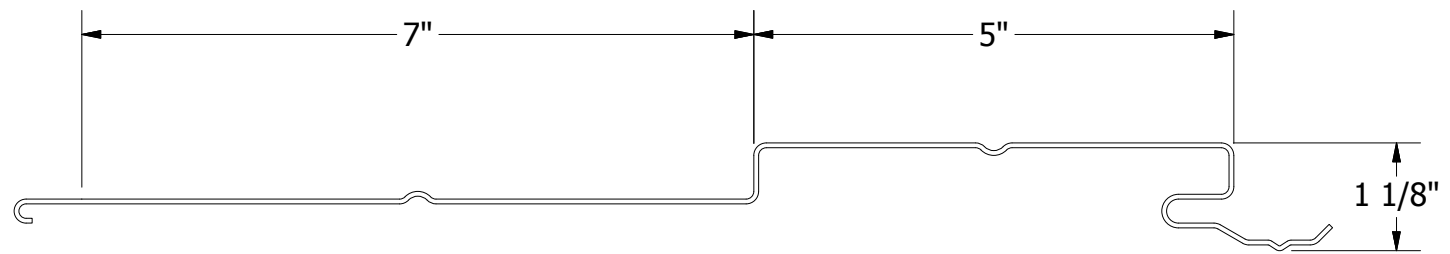
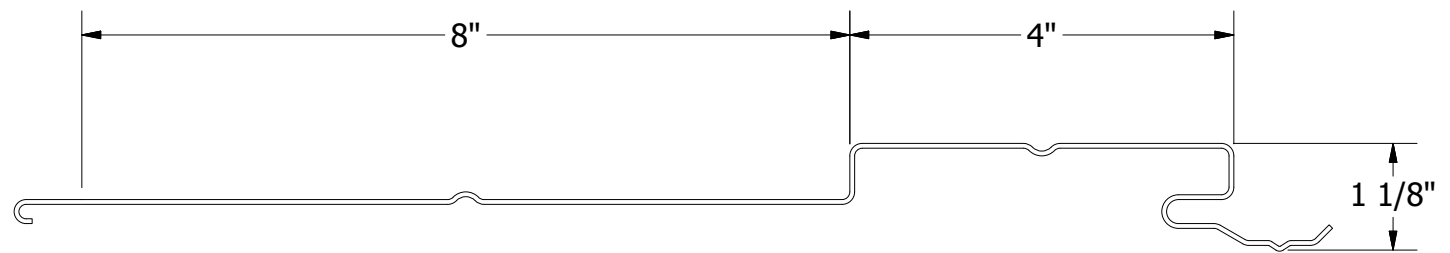
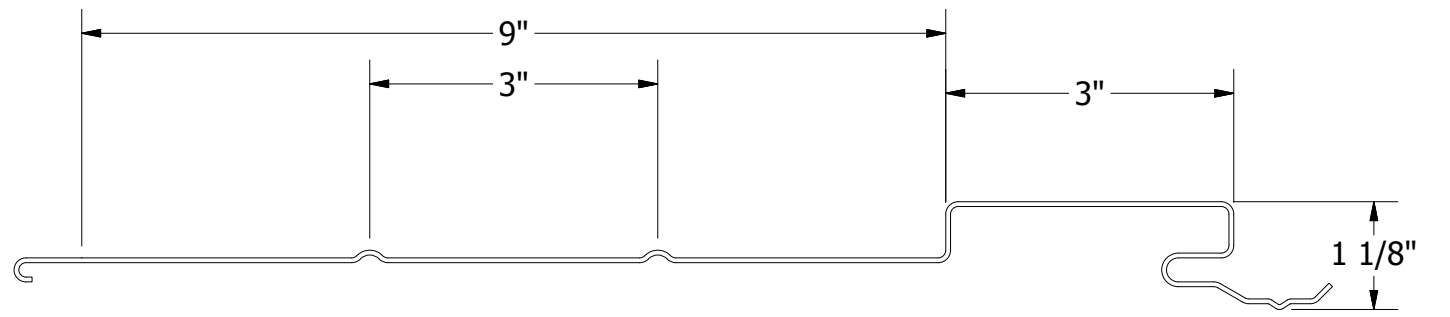
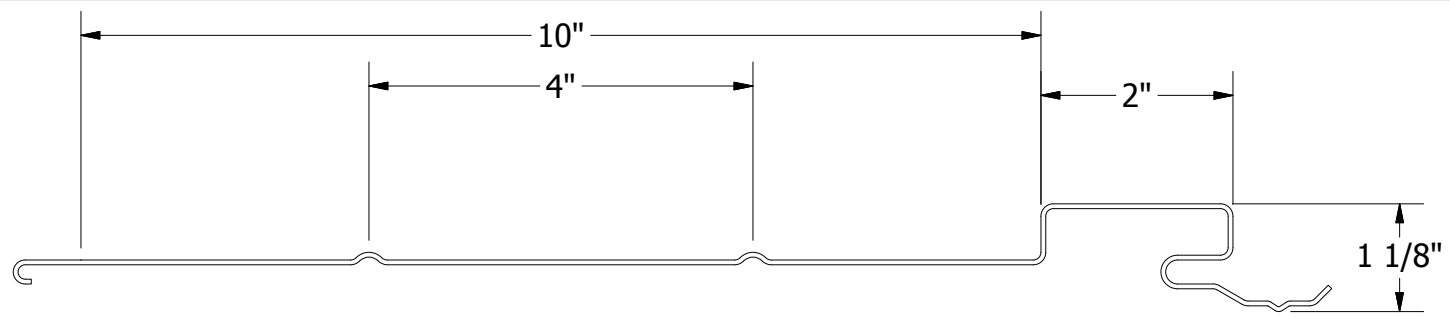

DWF & DWH Design Wall Panels

ATAS INTERNATIONAL, INC
 Allentown PA
 610-395-8445
 Mesa AZ
 480-558-7210

REV. NO.		DATE	DESCRIPTION OF REVISION	BY	APP	TITLE Design Wall Panel Profile Detail	
						DWG. NO.	DR KRK DATE 7/26/2016
						MATERIAL	APP DAS DATE 7/26/2016
						SH. SIZE	B SCALE X:X